

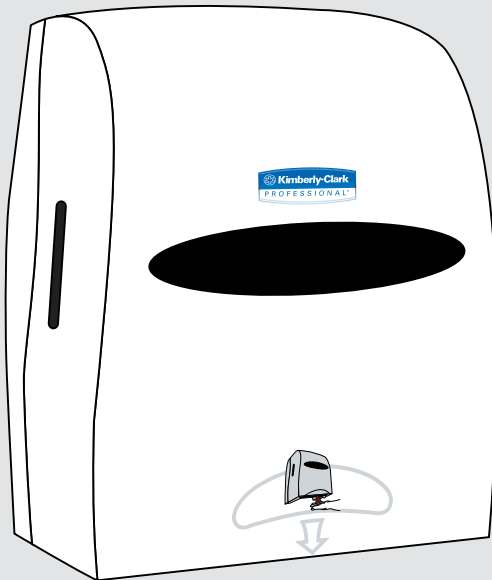

09960 • 09992 • 09993



<http://www.kcprofessional.com>



09960 • 09992 • 09993

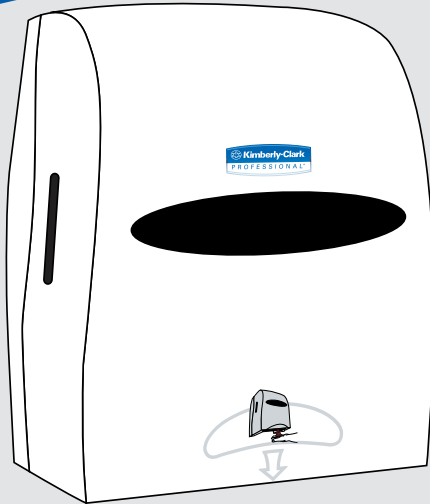

<http://www.kcprofessional.com>

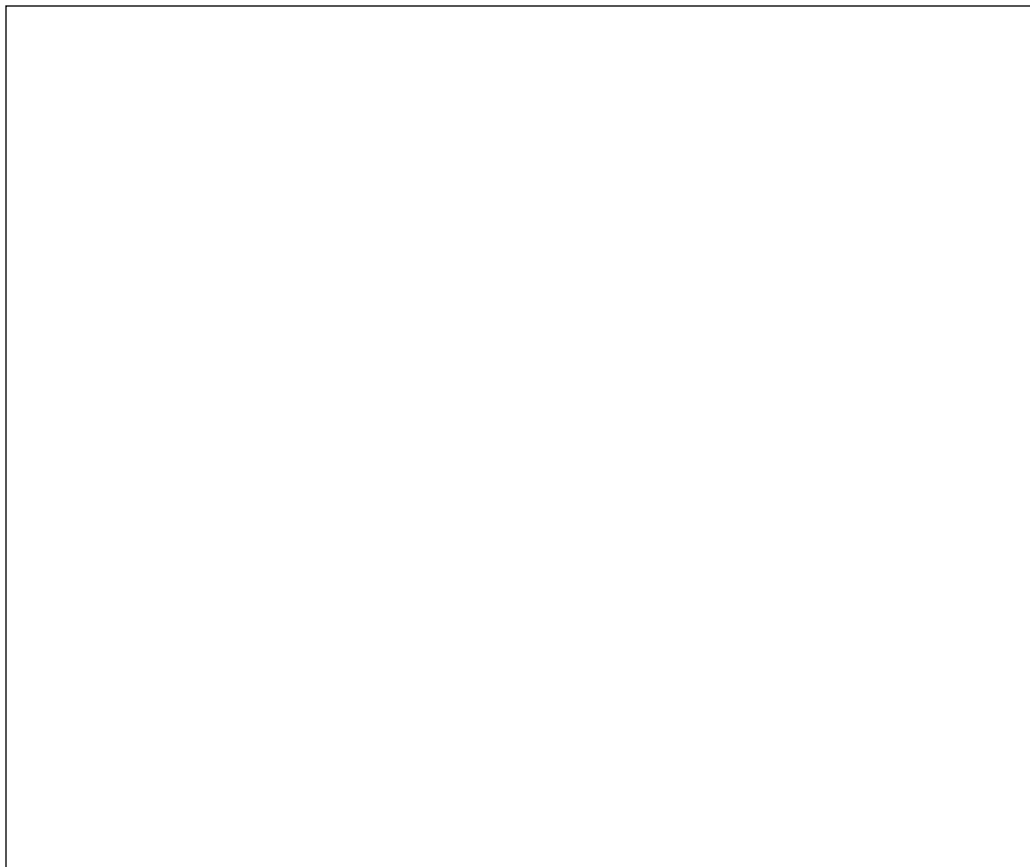

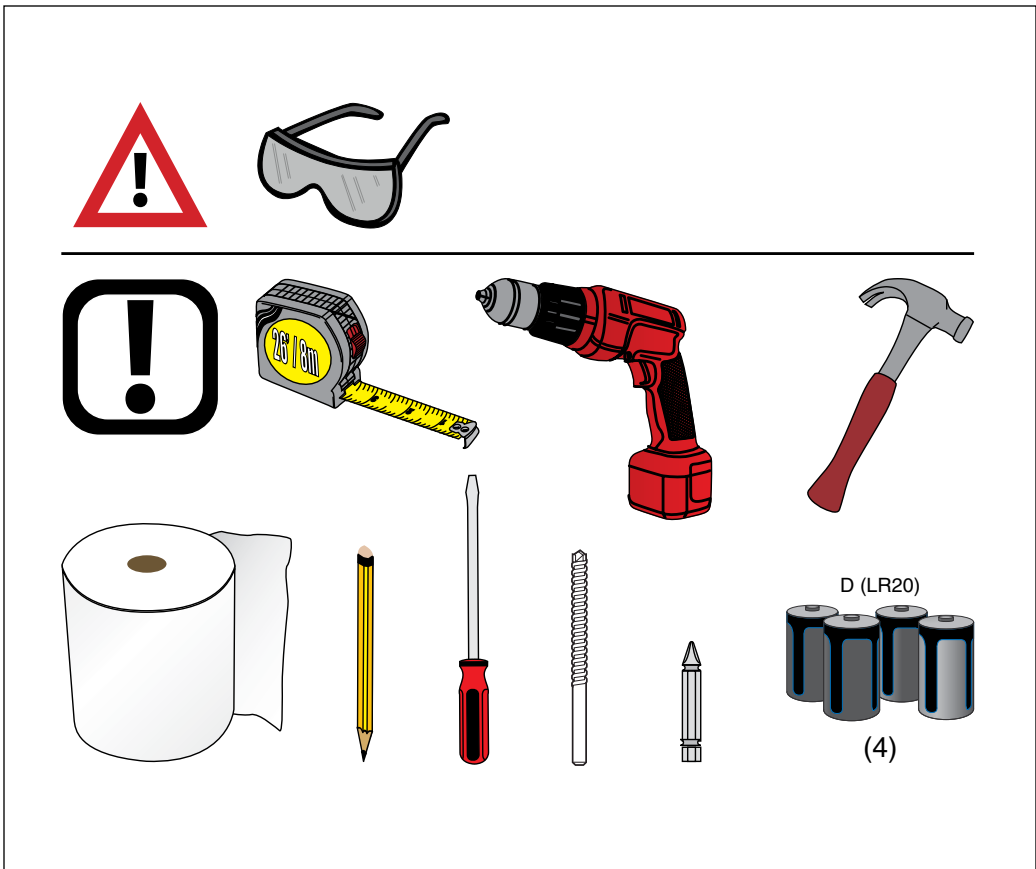
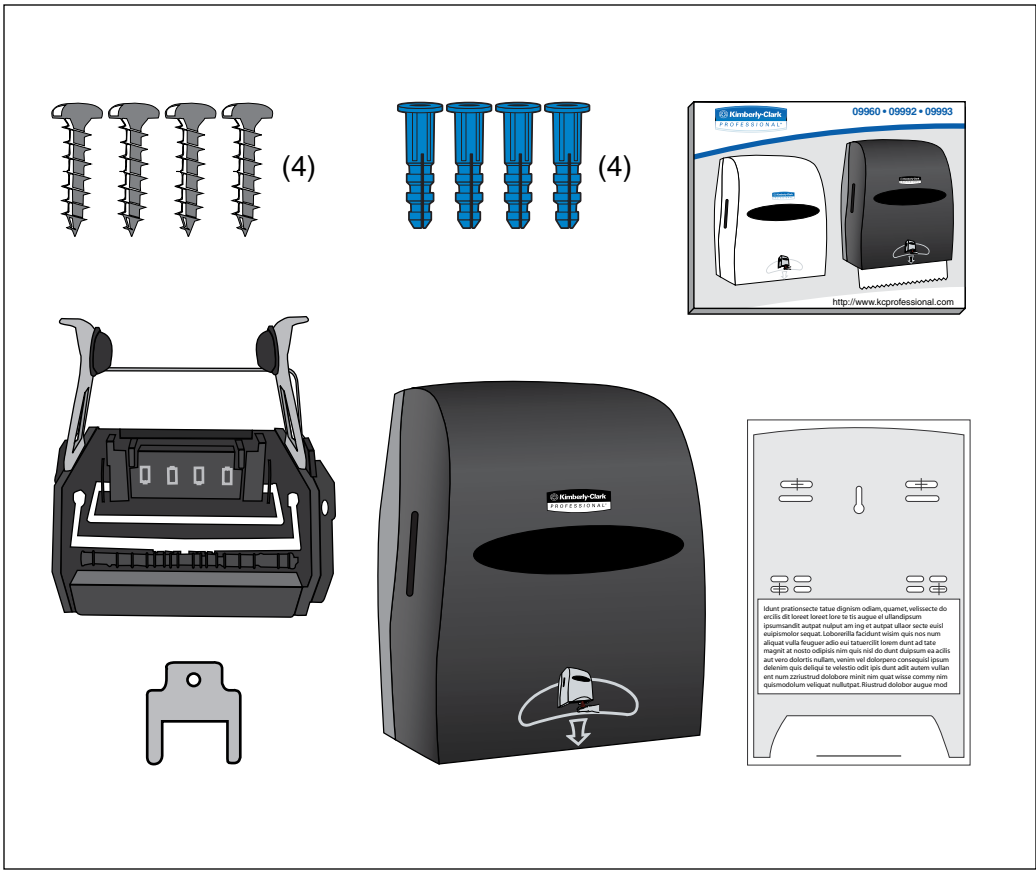

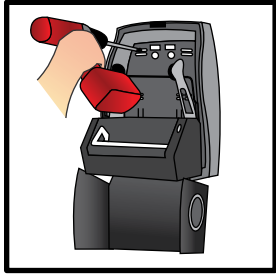

1

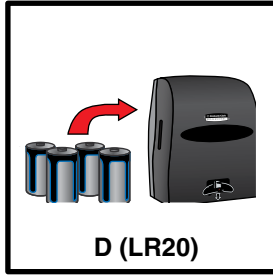

2

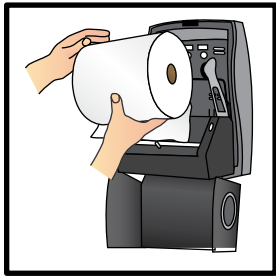

3

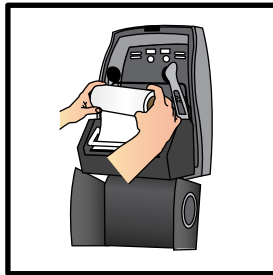

4

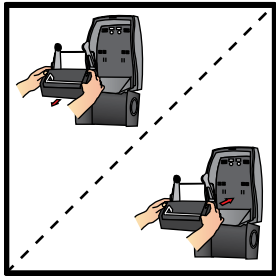

5

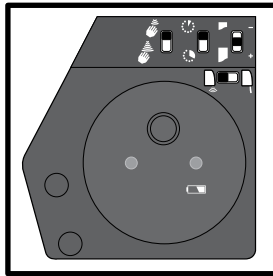

6

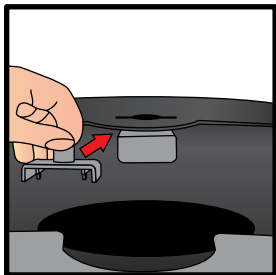

7

1.01

1

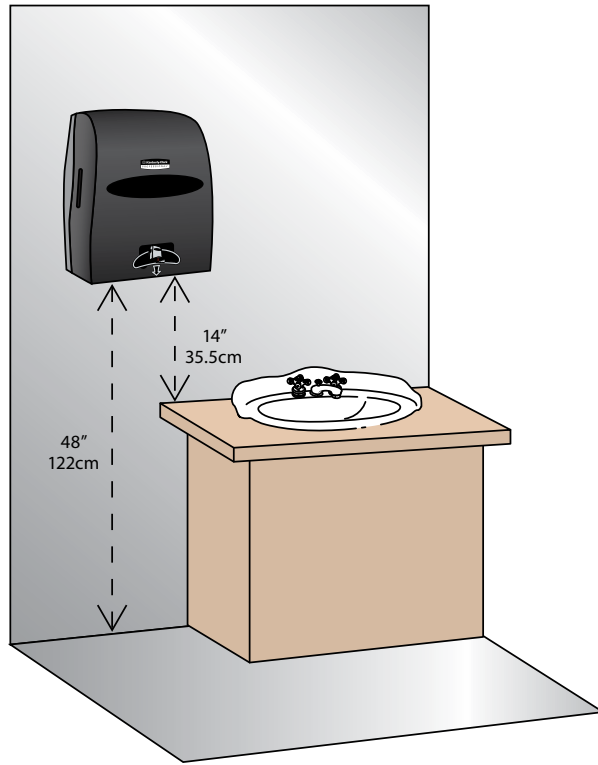

1.02

1

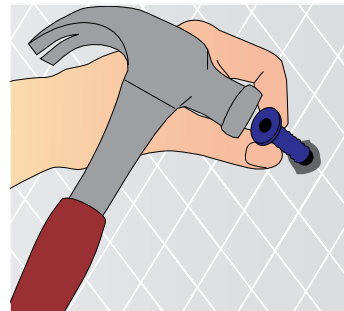
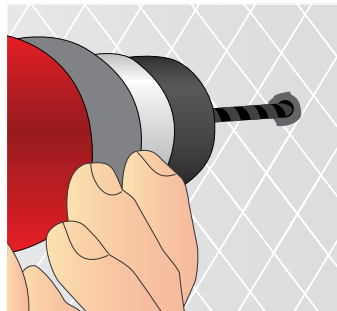
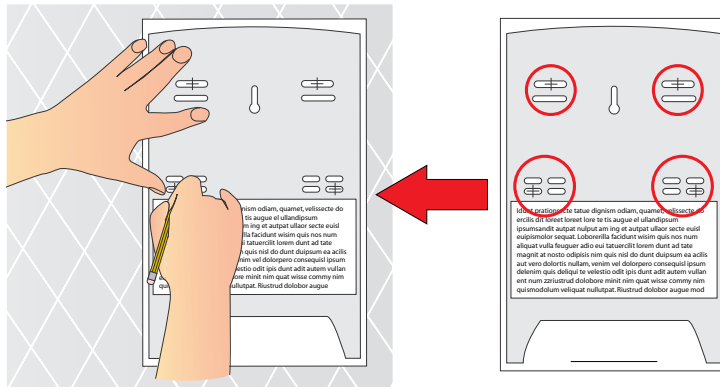

1.03

1

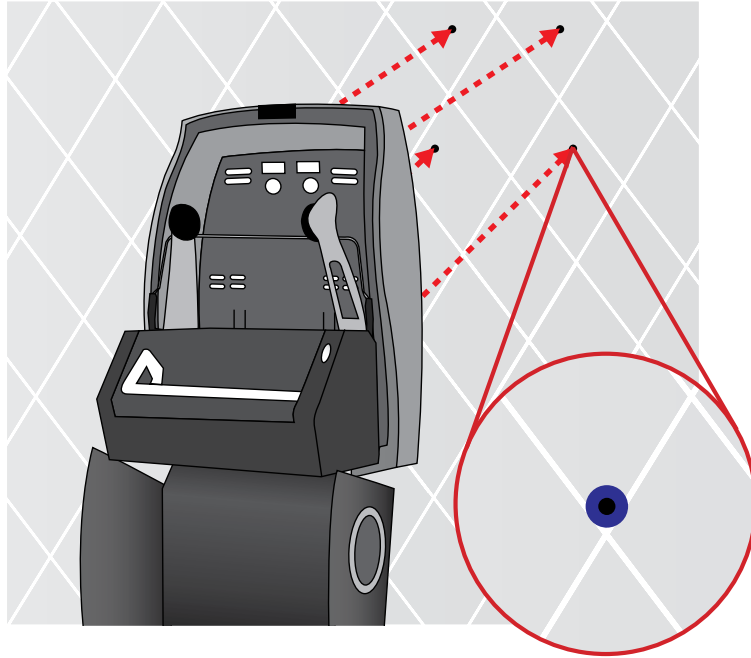

1.04

1

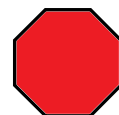
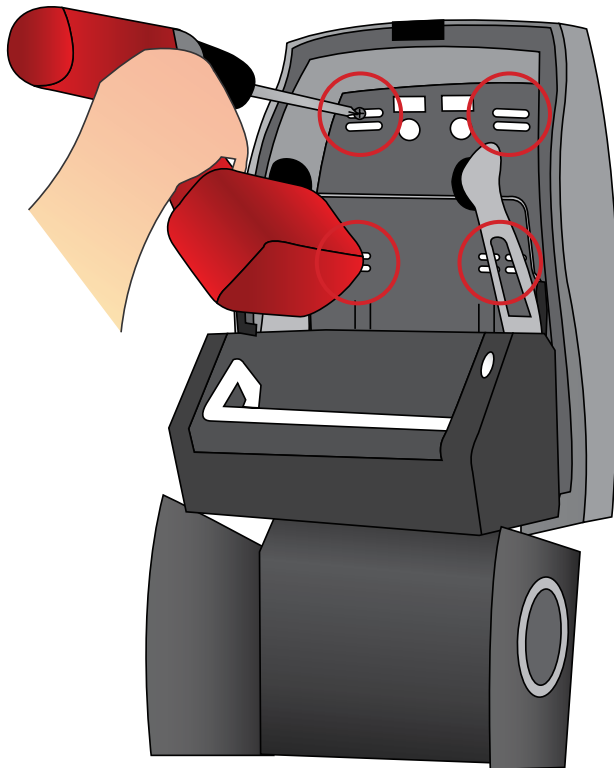

2.01

2

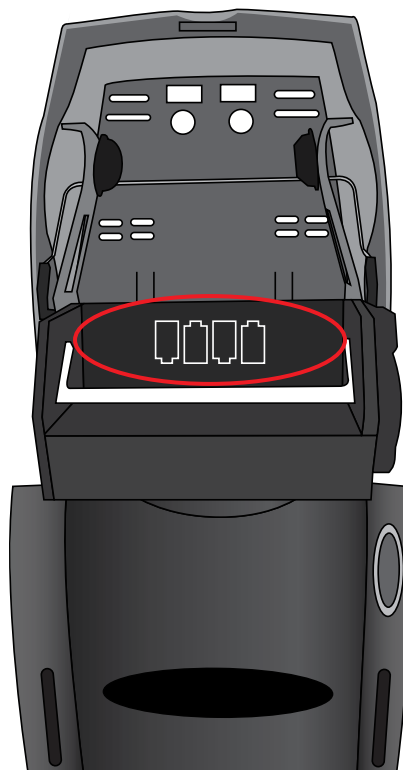

2.02

2

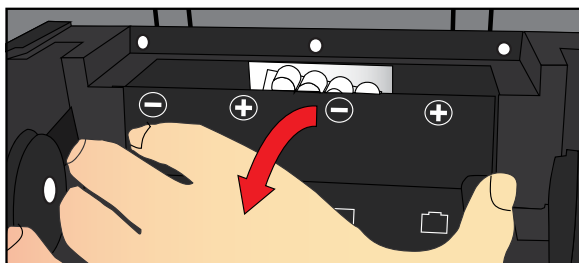
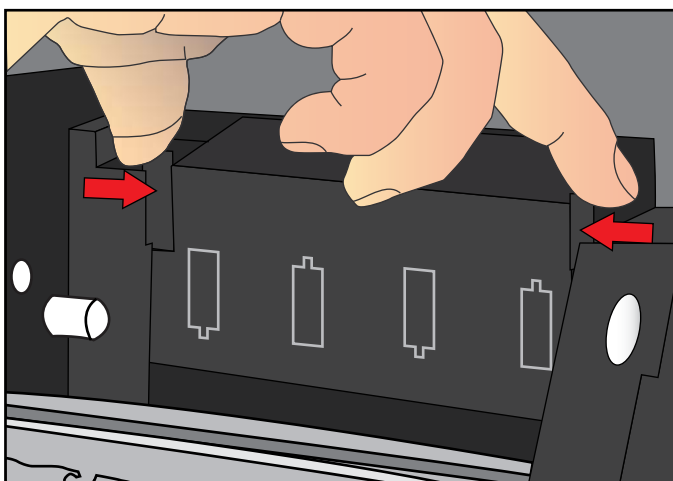

2.03

2

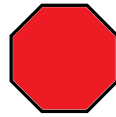
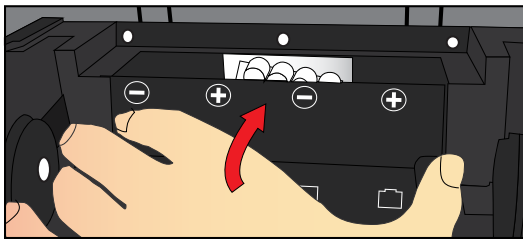
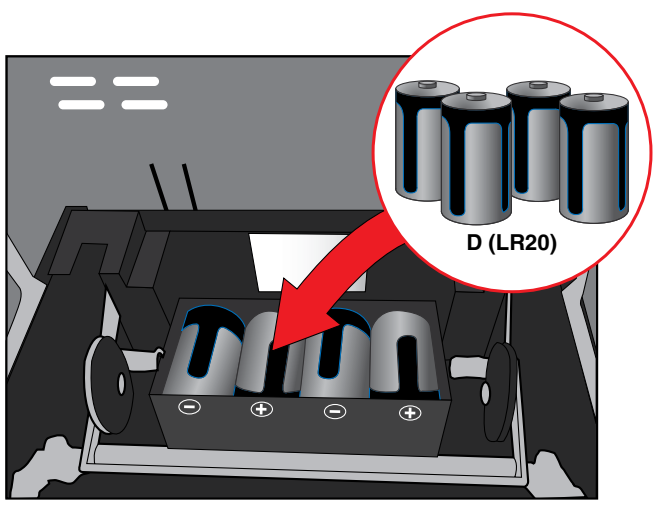

3.01

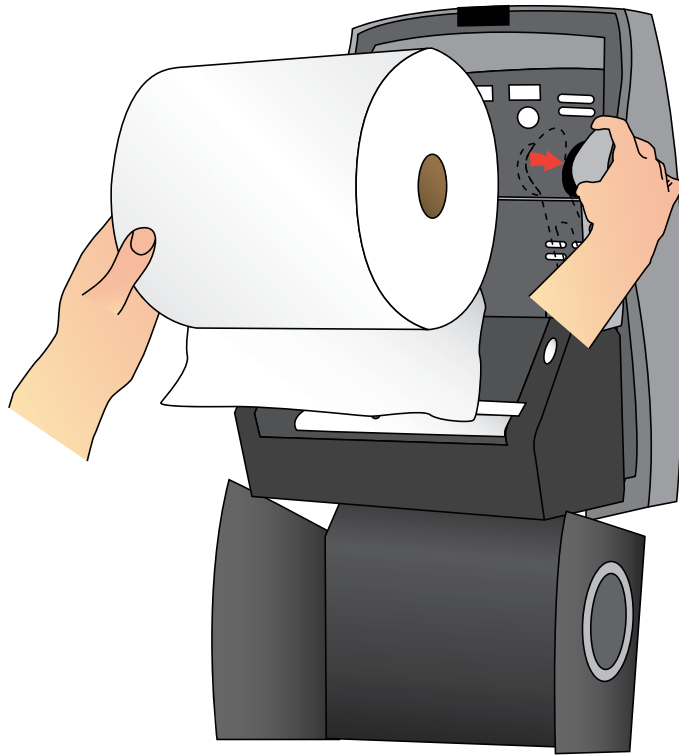

3

3.02

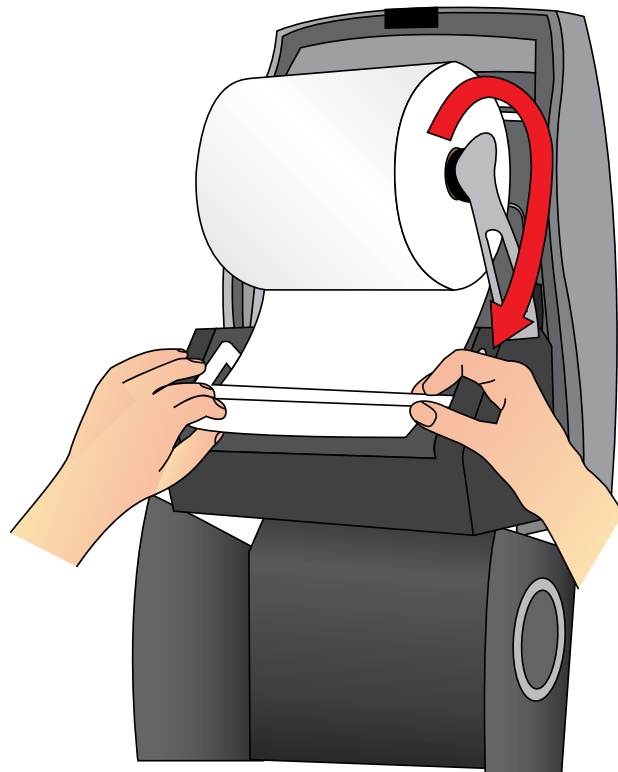

3

3.03

3

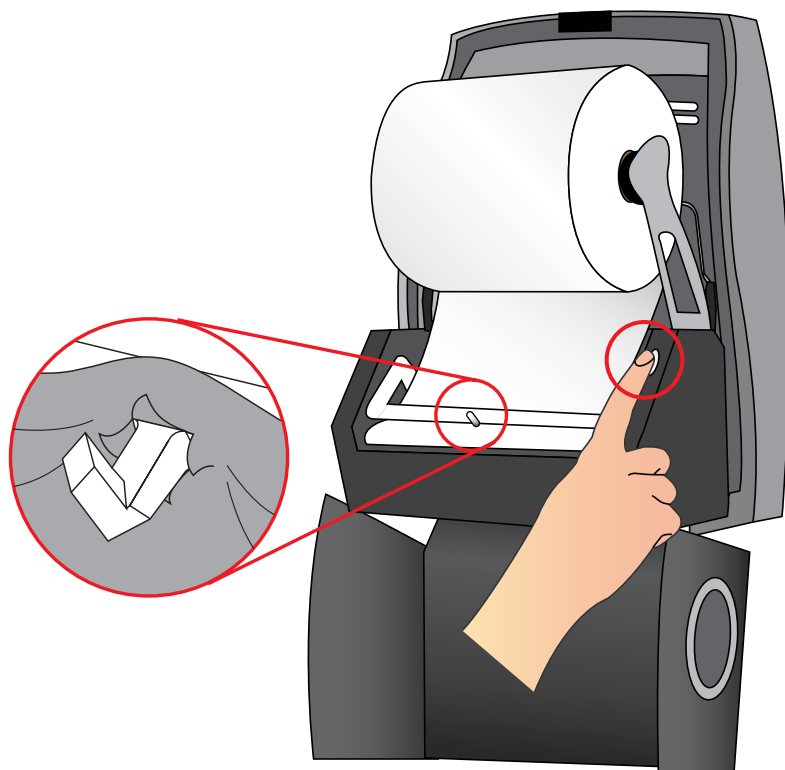

3.04

3

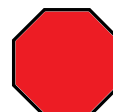
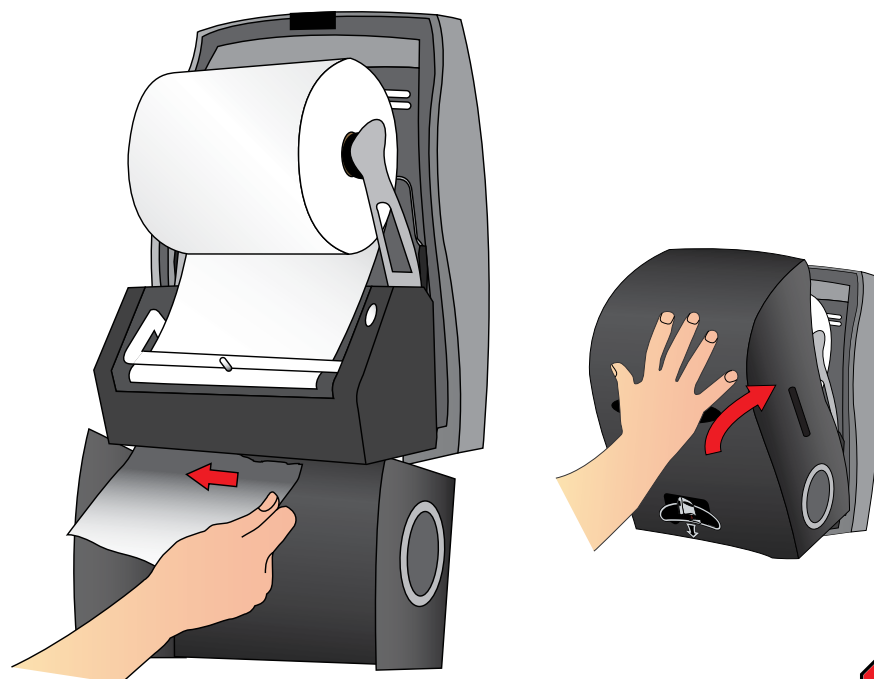

4.01



4

4.02

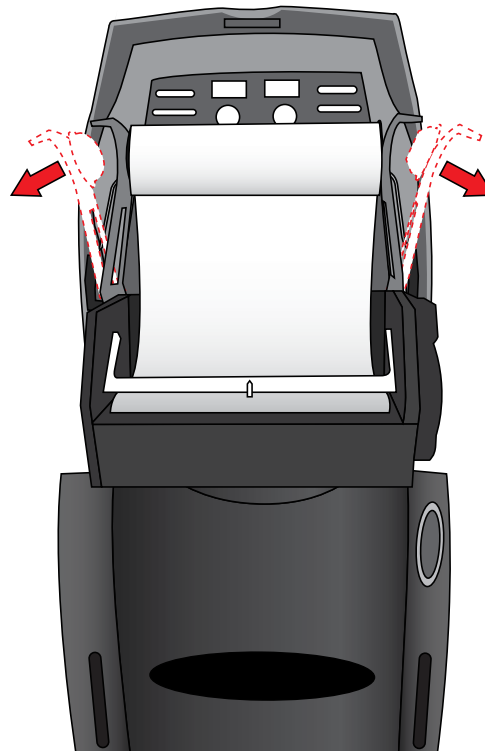

4

4.03

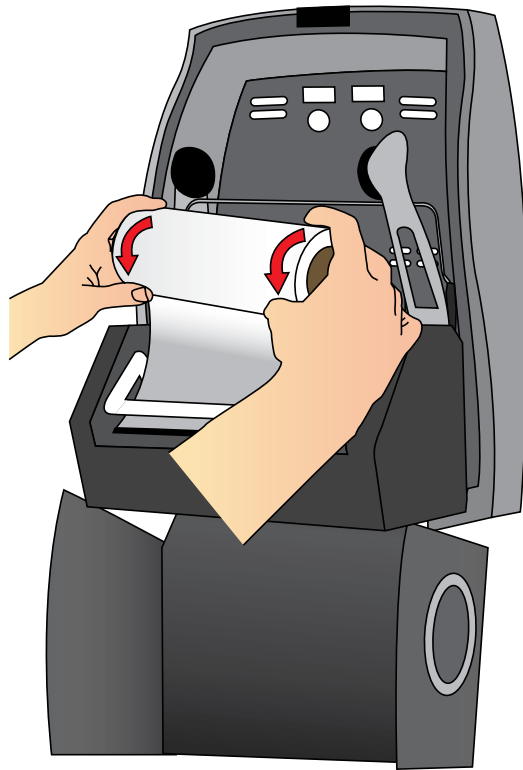

4

4.04

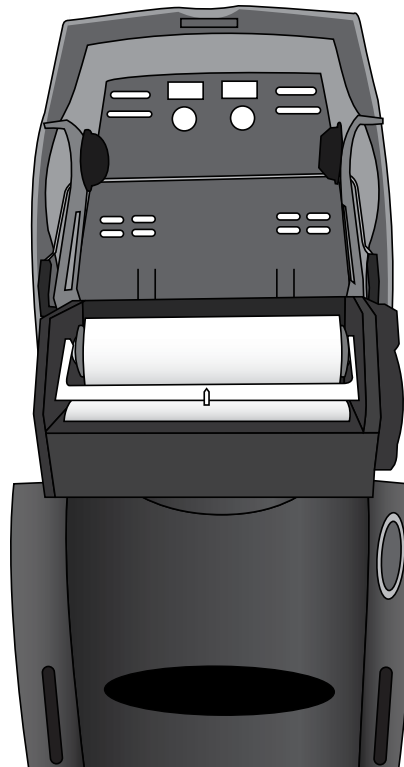

4

4.05

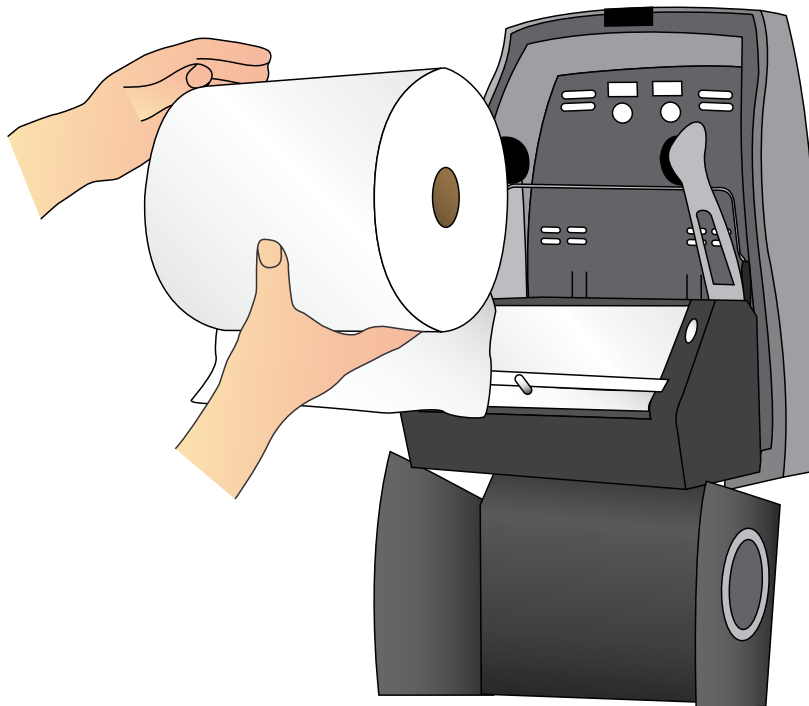

4

4.06

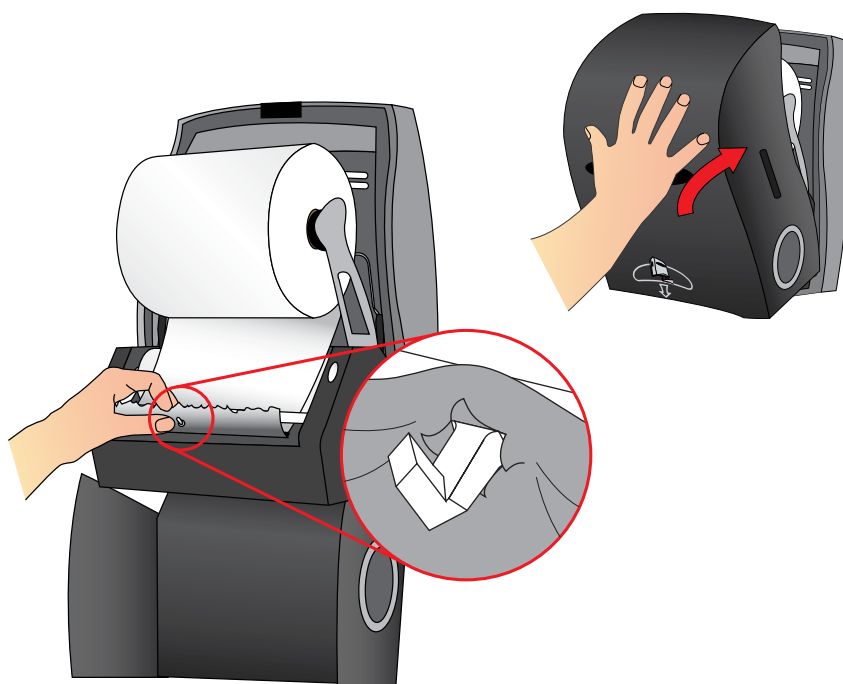

4

5.01



5

5.02

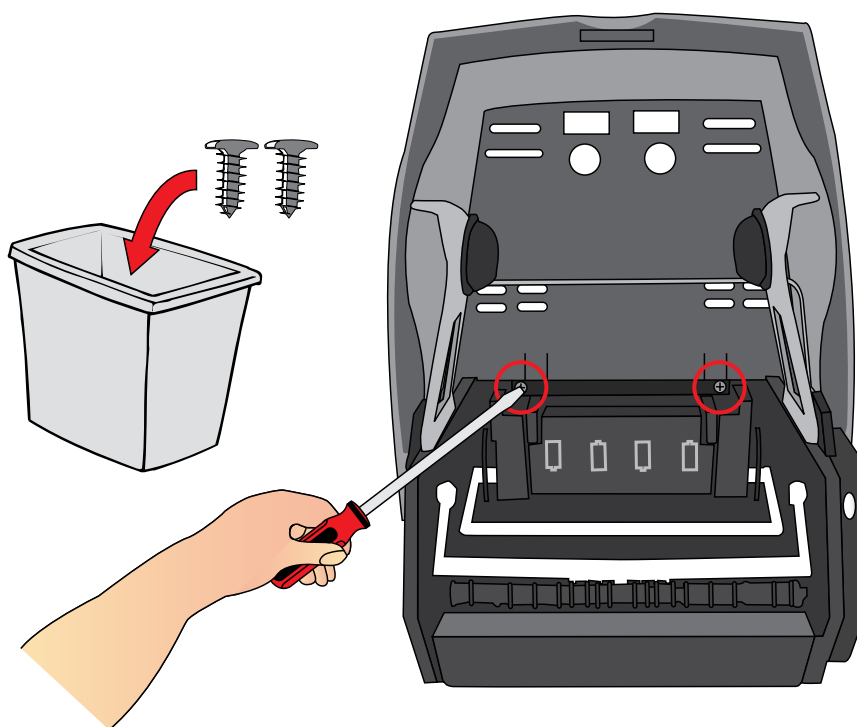

5

5.03

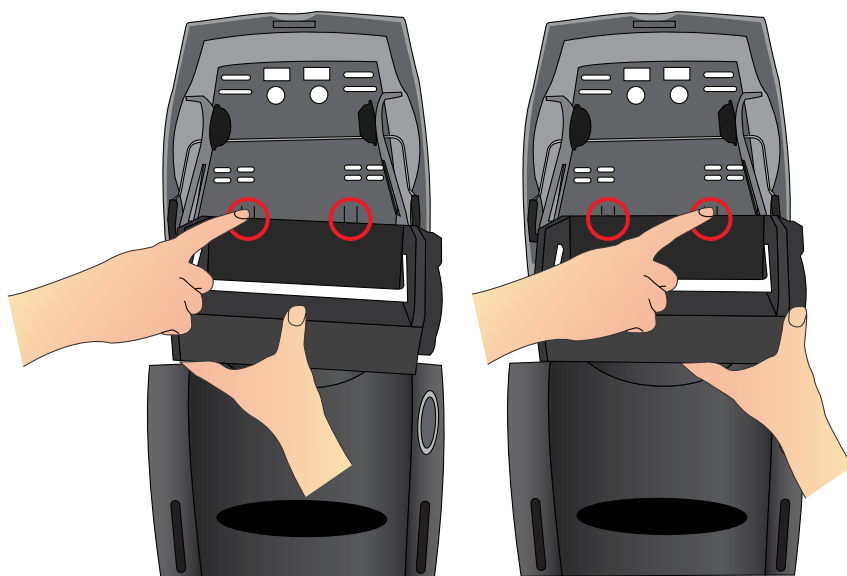

5

5.04

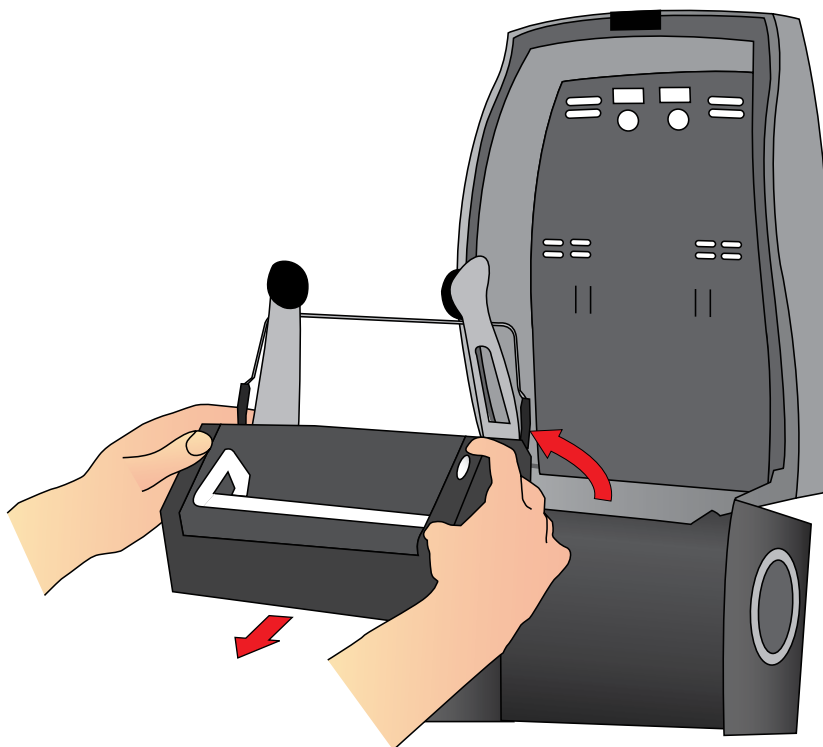

5

5.05

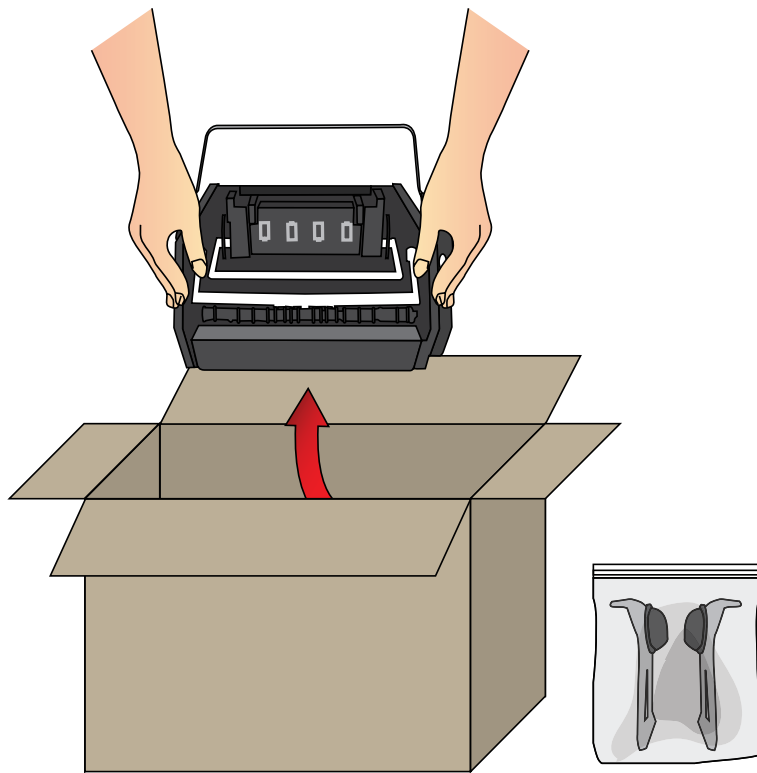

5

5.06

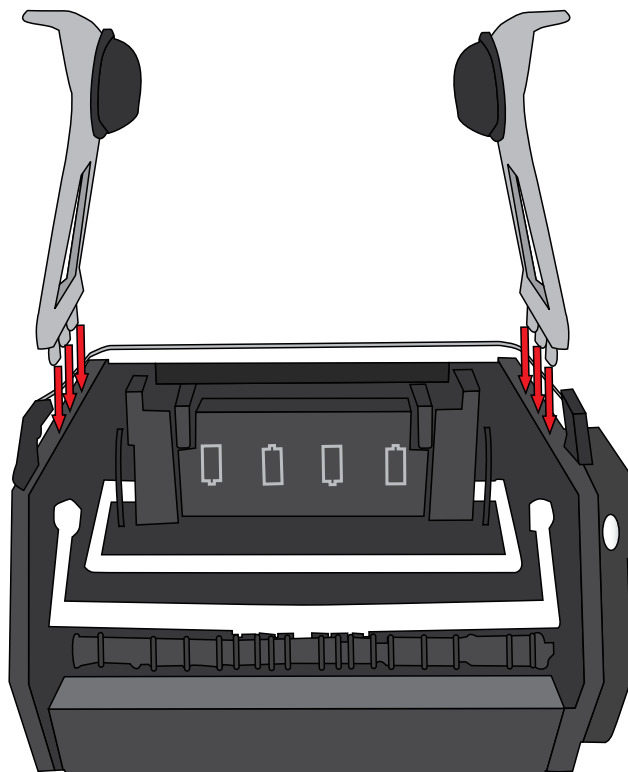

5

5.07

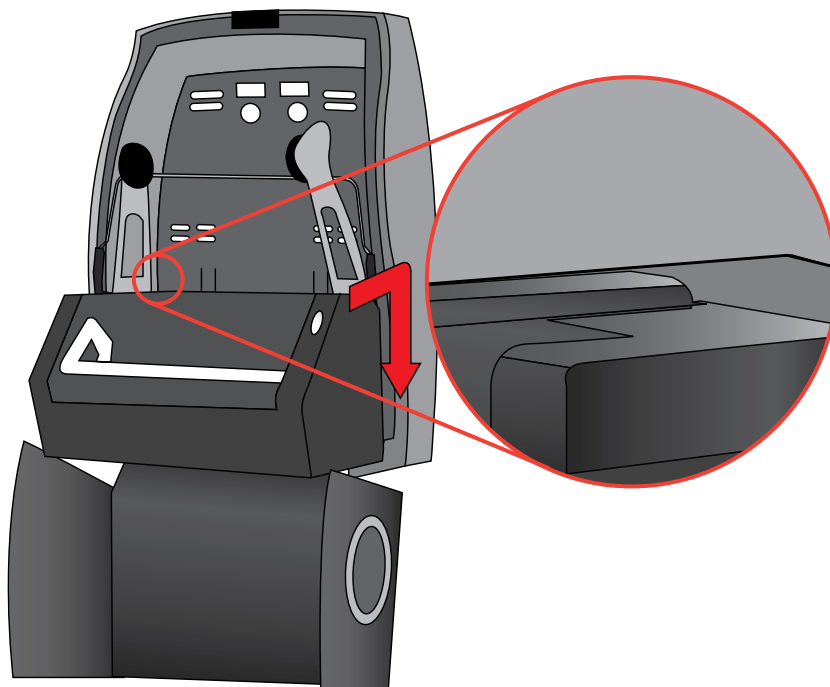

5

5.08

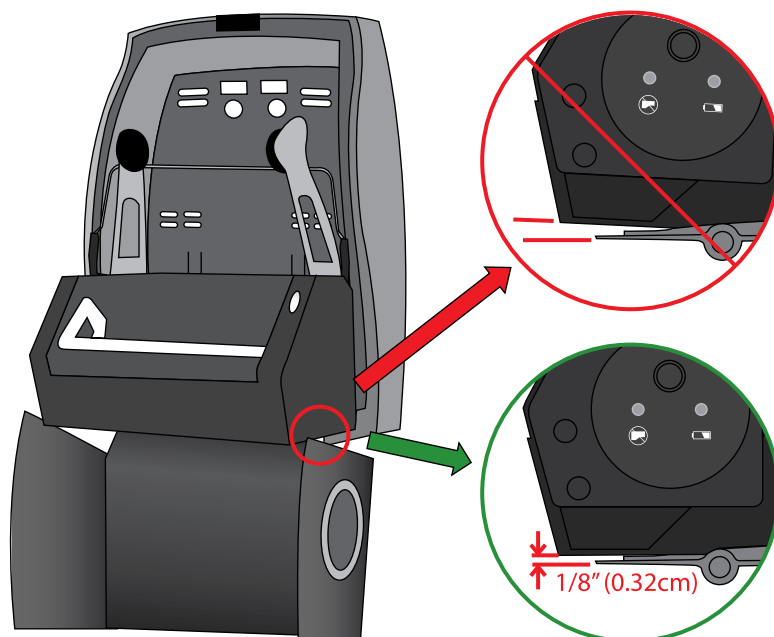

5

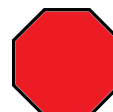

6.01



6

6.02

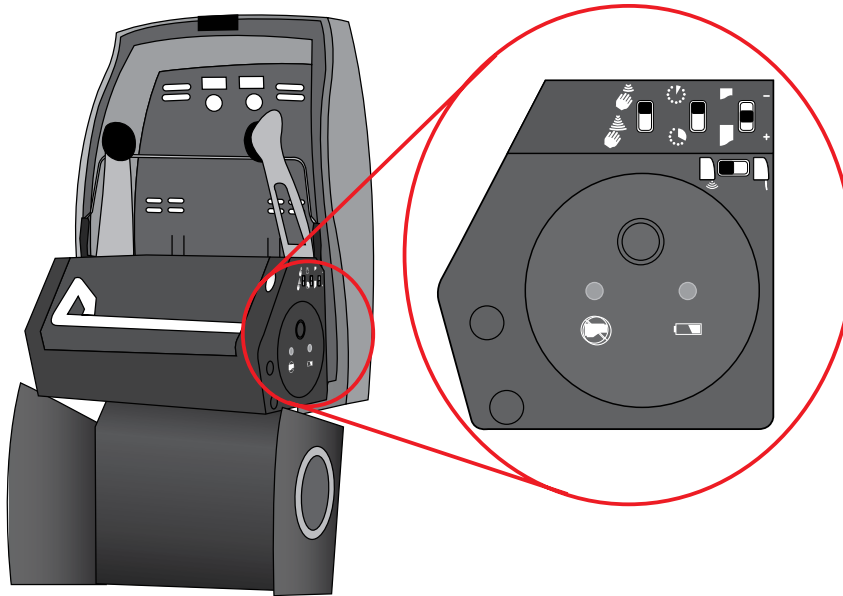

6

6.03

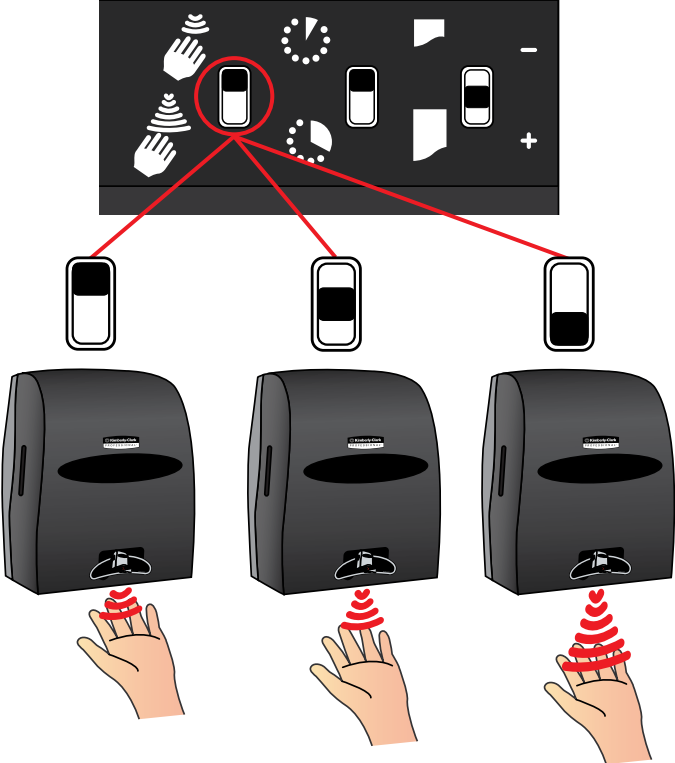

6

6.04

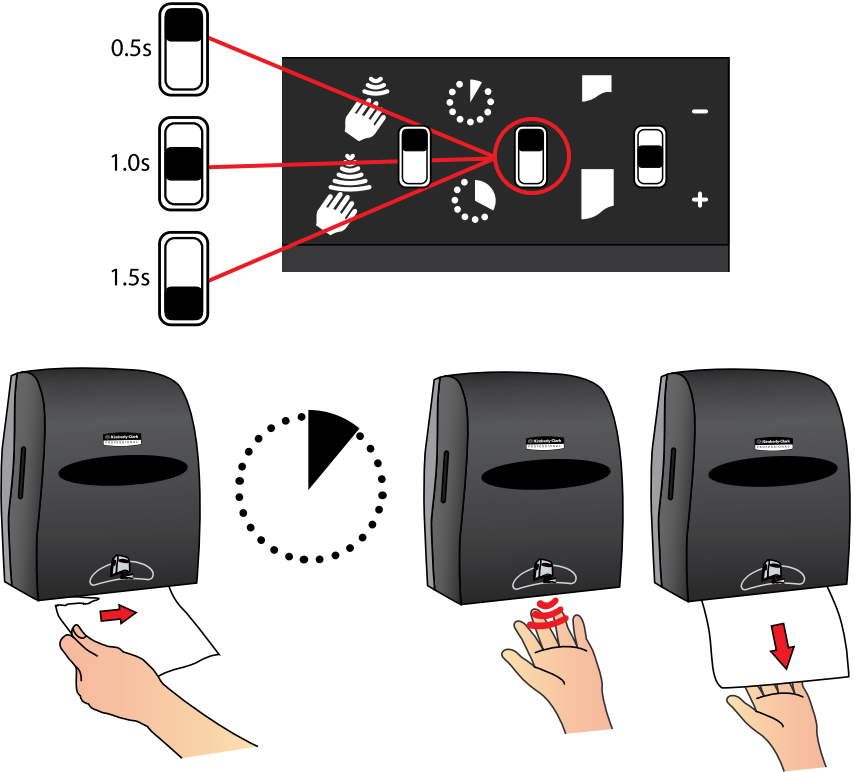

6

6.05

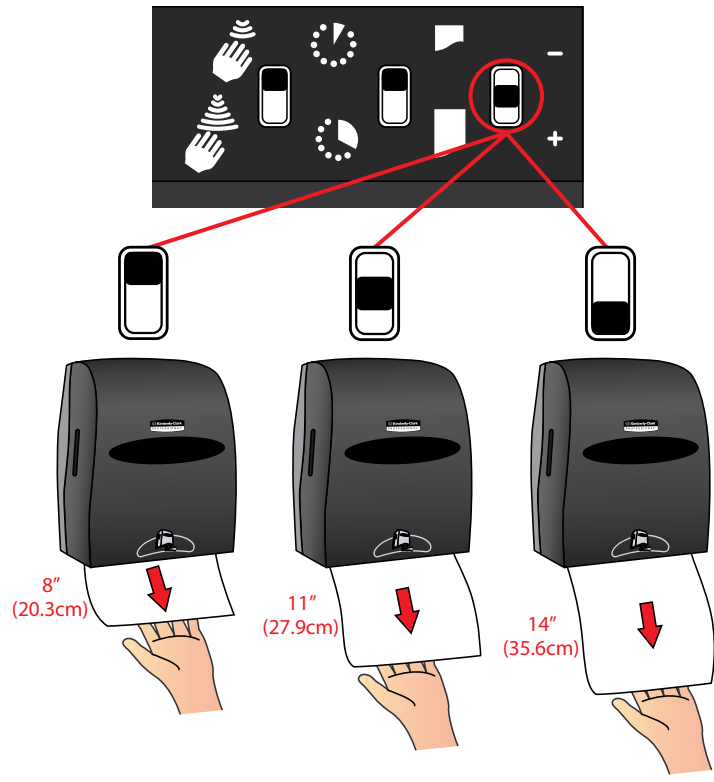

6.06

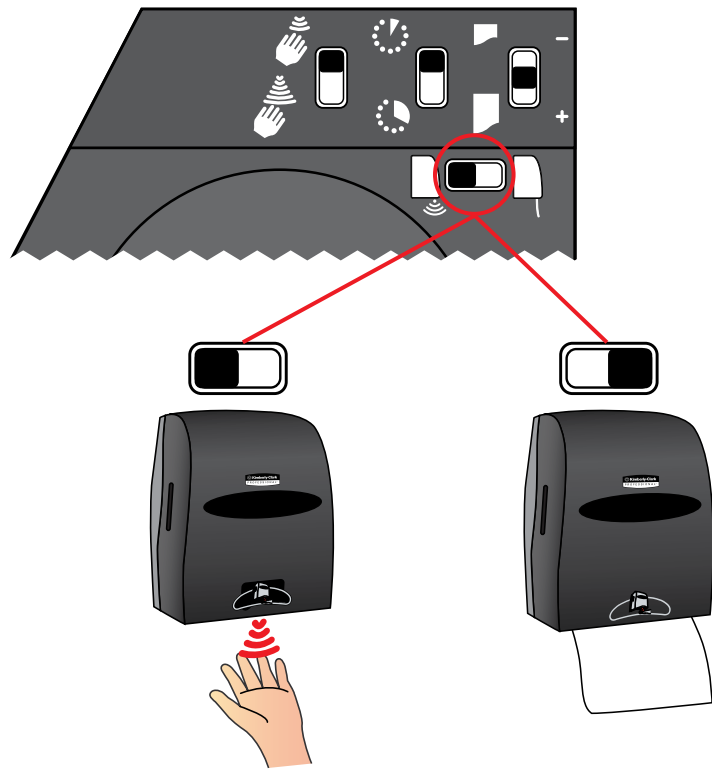

6.07

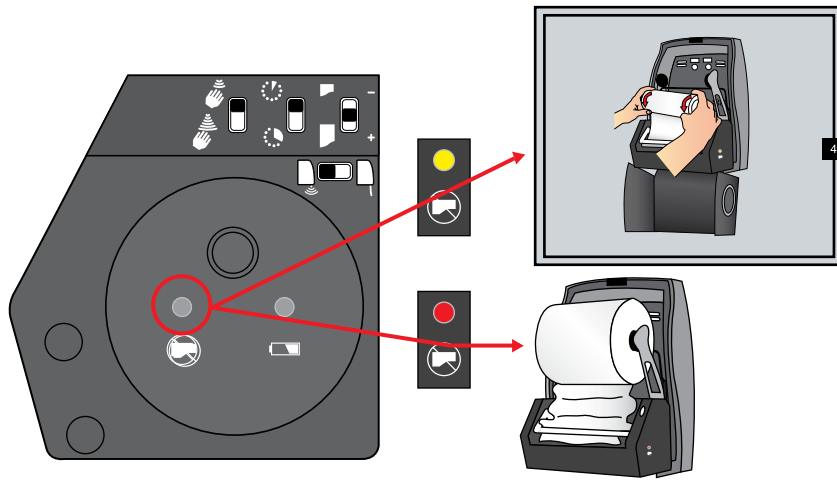

6

6.08



6

7.01



7

7.02

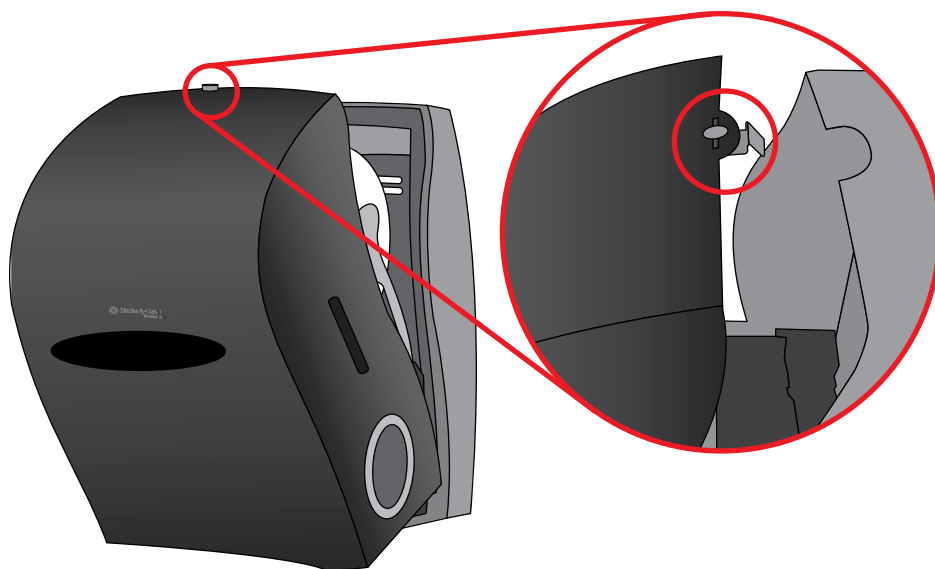

7

7.03

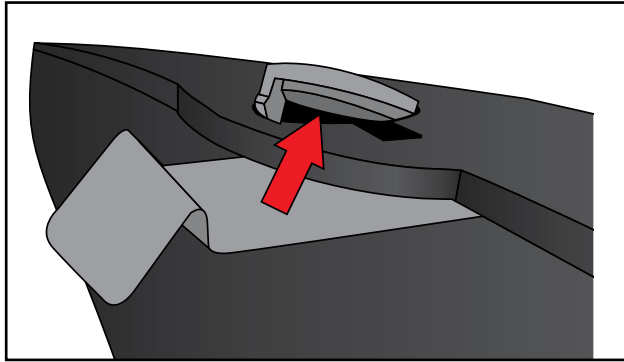
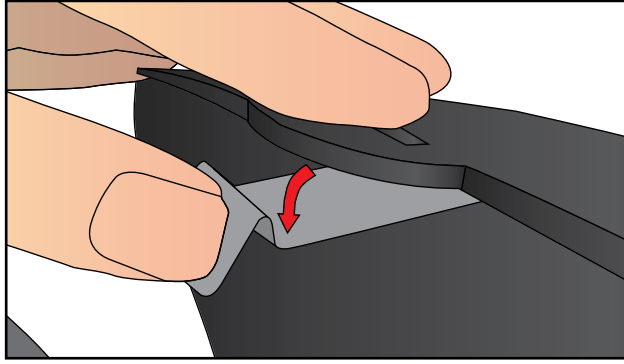

7

7.04

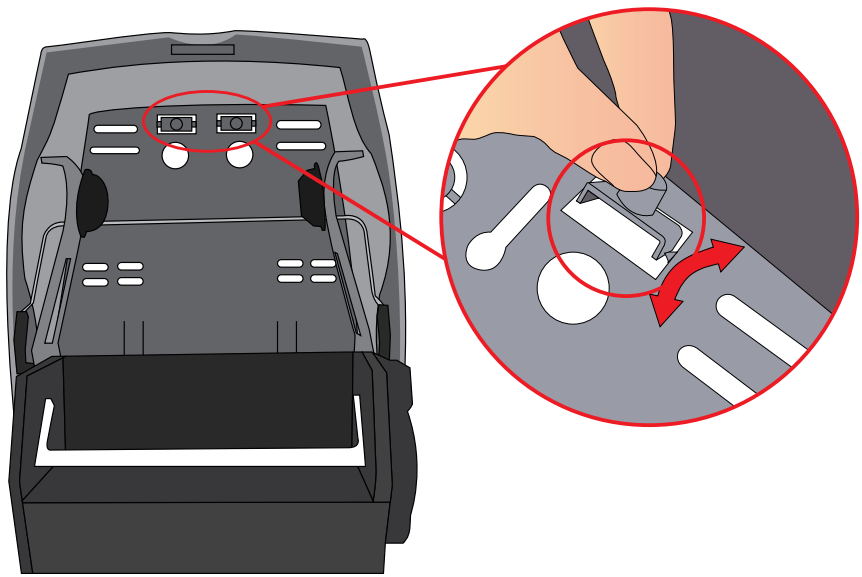

7

7.05

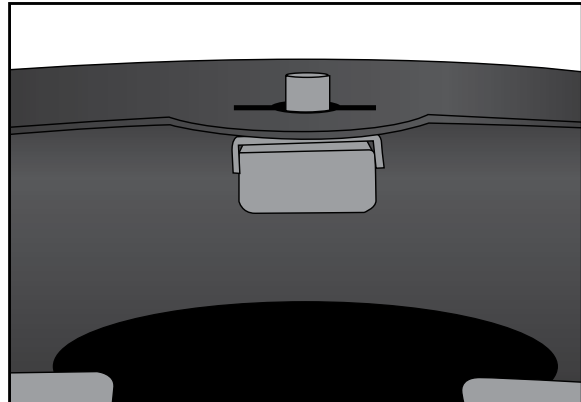
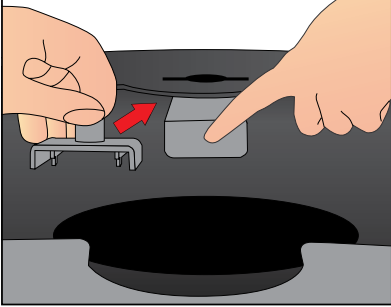



7

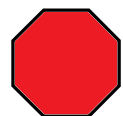

7.06

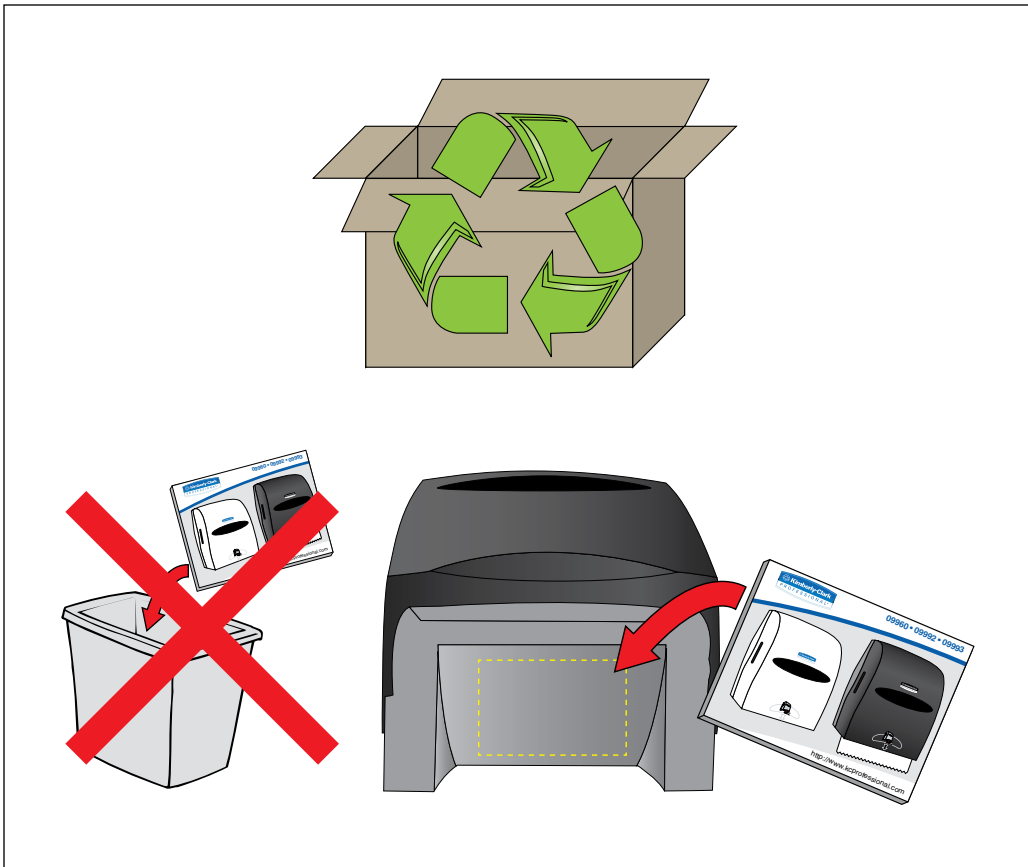

7



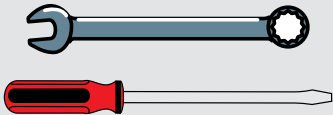

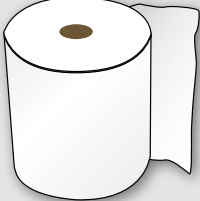

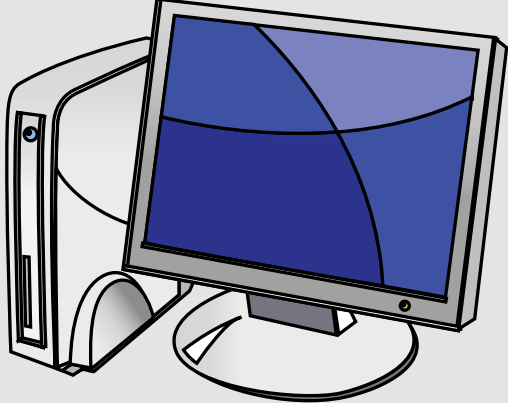
<http://www.kcprofessional.com>

©/* Trademarks of Kimberly-Clark Worldwide, Inc./Marques déposés de Kimberly-Clark Worldwide, Inc.
©2008 KCWW
Form 033923 • Rev. 3/2011